

REV	DATE	MODIFICATION	修改内容	DRAWN
B	2015/01/14		铁壳燕尾部位改为R角	Cathyli

SPECIFICATIONS
1. ELECTRICAL:
 UL APPLICATIONS: 250 VOLTS AC MAX., AT 2 AMPS.
 DIELECTRIC WITHSTANDING VOLTAGE : 1000 VOLTS AC.
 WITHSTAND VOLTAGE TIME: 60S.
 INSULATION RESISTANCE: 100 M Ω .
 TERMINATION: RESISTANCE 20m Ω MAX AFTER ENVIRONMENTAL TESTING.

2. MECHANICAL:
 CABLE-TO-PLUG TENSILE STRENGTH : 200ROUND MIN.
 DURABILITY : 200 MATING CYCLES.
3. MATERIAL & FINISH:
 HOUSING: POLYCARBONATE. UL94V-0 OR UL94V-2.
 COLOR : TRANSPARENT OR OTHER COLOR ARE AVAILABLE.
 CONTACT BLADE: COPPER ALLOY.
 CONDUCTOR : STRANDED & SOLID WIRE.
 (It can be used for the wire OD from ϕ 1.35- ϕ 1.45)
 GOLD PLATING: 3u"-50u" ARE AVAILABLE.

规范

1. 电器:

UL应用最大250VOLTS AC.
 介质耐电压伏特数:1000VOLTS AC.
 耐压时间:60S.

绝缘阻抗:100百万欧姆.

终端阻抗:在环境测试后最大可承受20微欧姆终端阻抗.

2. 机构

拉力测试:至少20磅.
 耐力测试:至少200次之插拔测试.

3. 材质表面处理

塑胶壳:聚碳酸酯, UL-94V-0 or UL94V-2.
 颜色:透明,或者其他颜色亦可.

金片:铜合金.

导体:多股线&单股线.

(芯线直径: ϕ 1.35- ϕ 1.45均可适用)

镀金厚度:3u"-50u" 皆可提供.

客户用产品图

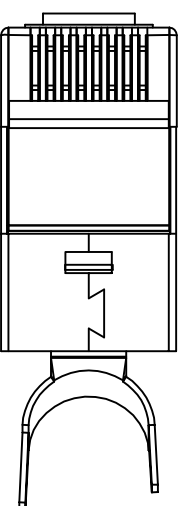
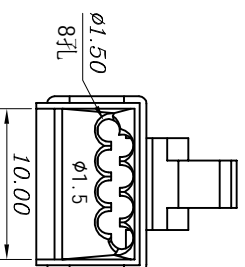
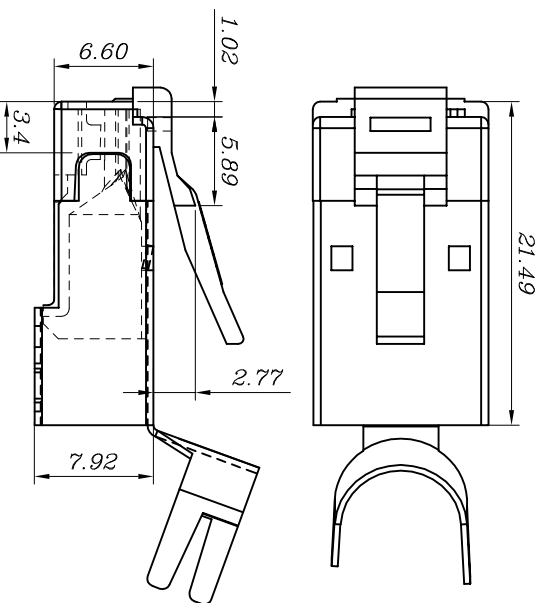
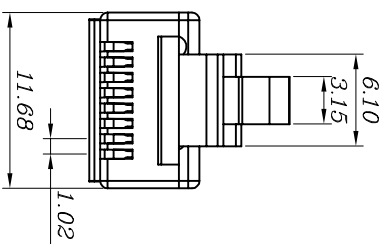
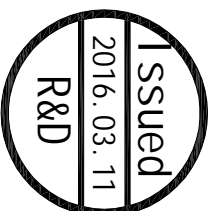

BLADE:	E	EB	Y	YB	Z	A	AE	AB	EC	AL	ZL	YBL
Drawing												
Mark					✓						✓	
GOLD PLATING	3Mu"	3u"	6u"	15u"	30u"	50u"						
Mark						✓						
								CABLE TYPE	ROUND	FLAT		
								Mark	✓			

EXW 宁波卓新通讯插件有限公司 NINGBO EXCELLENCE COMMUNICATED CONNECTOR CO.,LTD		材 质	MATERIAL	图 号	DWG NO.
DIMENSION IN mm (Inch)		PC	PLUG-154-0001		
TOLERANCE UNLESS OTHERWISE SPECIFIED					
X \pm 0.20	X \pm 5°				
.XX \pm 0.10	.XX \pm 2°				
审核	核 对	制 图	比 例	张 数	修 改
沈红波	钟均江	Cathyli	2/1	1/1	B
PROJ.	PROJ.	PROJ.	PROJ.	PROJ.	REV

1 2 3 4 5 6 7

D C B A

1 2 3 4 5 6 7

D C B A

ST-DR-009A

更改 REV	日期 DATE	变更内容 MODIFICATION	修改 DRAWN
D	2017/06/15	外形更改 Δ	Zach

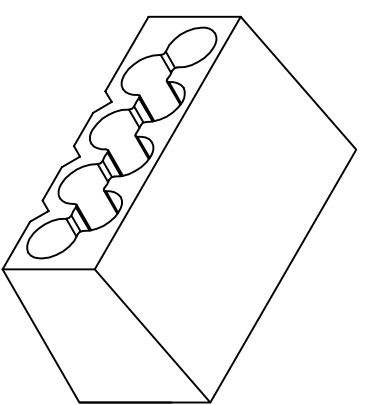
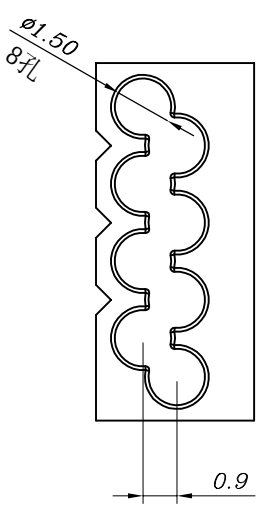
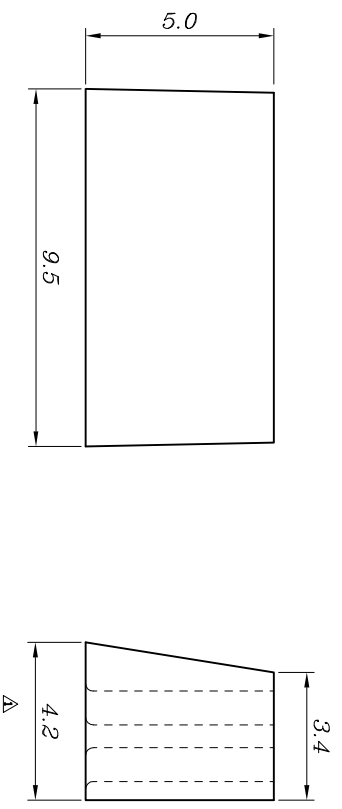

客户用产品图

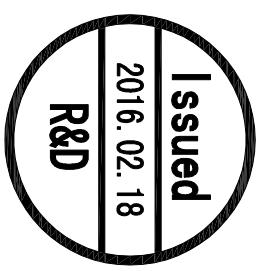

		宁波卓新通讯插件有限公司 NINGBO EXCELLENCE COMMUNICATED CONNECTOR CO.,LTD	
DIMENSION IN mm (Inch) TOLERANCE UNLESS OTHERWISE SPECIFIED		材 质 MATERIAL	图 号 DWG NO
$X \pm 0.20$ $.XX \pm 0.10$		PC	PLUG INSERT-040A
名称 TITLE		3Y双排支架(线孔1.5)	
审 核 APPROVAL	核 对 CHECKED	制 图 DRAWN	比 例 SCALE
		Zach	5/1
		角法 FRONT	张数 SHEET
			1/1
		理 改 REV	
		D	

ST-DR-009A